







# SUMMARY OF PEDESTALS AND STORAGES FEATURES IN INDIVIDUAL SYSTEMS.

## PEDESTALS

	BASIC	STANDARD	PRO	GLOSS
<b>drawer</b>	MFC	metal	metal	metal
<b>body</b>	white, aluminum or anthracit	available in all colours (group I & II)	available in all colours (group I & II)	black, white, aluminum or anthracite
<b>top and front</b>	MFC in all colours	MFC in all colours	MFC in all colours	in all gloss HPL colours
<b>pencil tray</b>	plastic pencil tray	plastic pencil tray or separate pencil drawer	plastic pencil tray or separate pencil drawer	pencil tray
<b>ball runners</b>	not available	optional	optional	optional
<b>soft closing</b>	not available	optional	optional	optional
<b>handles</b>				no handles

## CABINETS

	BASIC	STANDARD	PRO	GLOSS
<b>back</b>	3mm HDF	18mm MFC	18mm MFC	18mm MFC
<b>body</b>	white, aluminum or anthracite	available in all colours (group I & II)	available in all colours (group I & II)	black, white, aluminum or anthracite
<b>handles</b>				push-to-open
<b>metal base</b>	not available	not available	optional	optional
<b>wide angle hinges</b>	not available	optional	optional	not available
<b>glass top for storages 801mm wide</b>	ordered as separate element	ordered as separate element	ordered as separate element	ordered as separate element

## TECHNICAL SPECIFICATION

### COLOURS

#### TOP, BOTTOM



14 BEECH    26 ALUMINUM SATINATO    31 CANADIAN OAK    34 CHESTNUT    39 POLAR BIRCH



64 COCOA    67 WHITE PASTEL    106 LOWLAND NUT    154 ANTHRACITE



#### BODY



26 ALUMINUM SATINATO    67 WHITE PASTEL    154 ANTHRACITE



#### FRONT



14 BEECH    26 ALUMINUM SATINATO    31 CANADIAN OAK    34 CHESTNUT    39 POLAR BIRCH



64 COCOA    67 WHITE PASTEL    106 LOWLAND NUT    154 ANTHRACITE



#### MOBILE PEDESTAL KKT11, KKT110



26 ALUMINUM SATINATO    67 WHITE PASTEL    154 ANTHRACITE



#### CUSHION SKP13 - FABRIC NEMO



NE-1 BEIGE    NE-2 YELLOW    NE-3 ORANGE    NE-5 RED    NE-9 GREEN





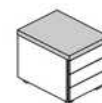
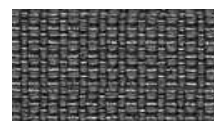







NE-10 GREY    NE-14 DARK GREY    NE-15 NAVY BLUE    NE-16 BLACK    NE-17 BLUE

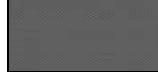

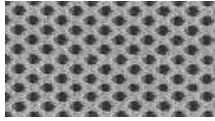







**TECHNICAL SPECIFICATION**

**COLOURS**

**CUSHION SKP13 - FABRIC RUNNER - SECOND GROUP**

 R-63034 ORANGE	 R-64089 RED	 R-66063 BLUE	 R-60011 GREY	 R-68056 GREEN		
 R-66064 NAVY-BLUE	 R-60999 BLACK	 R-60025 DARK GREY	 R-61128 BEIGE			

**CUSHION SKP13 - FABRIC MEDLEY - SECOND GROUP**

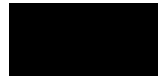
 M-68005 DARK OLIVE	 M-68002 LIGHT OLIVE	 M-68115 GREEN	 M-61002 BEIGE	 M-67053 NAVY BLUE		
 M-67006 LIGHT BLUE	 M-66008 GREY	 M-64019 RED	 M-63064 PINK	 M-60999 BLACK		

**CUSHION SKP13 - FABRIC ATLANTIC - SECOND GROUP**

 A-67043 DARK TURQUOISE	 A-67030 SEA-GREEN	 A-60141 LIGHT GREY	 A-60011 GREY	 A-66064 NAVY BLUE		
 A-65037 VIOLET	 A-62048 OLIVE	 A-64089 RED	 A-61078 BEIGE	 A-60025 GRAPHITE		

**CUSHION SKP13 - FABRIC BLAZER - THIRD PRICE GROUP**

 CUZ39 ORANGE	 CUZ63 RED	 CUZ1L GREEN	 CUZ12 GRAPHITE	 CUZ02 TURQUOISE		
 CUZ1V BLUE	 CUZ1X PINK	 CUZ1G GREY	 CUZ28 LIGHT GREY	 CUZ47 BEIGE		
 CUZ1R - SEA-GREEN						

**CUSHION SKP13 - FABRIC XTREME - THIRD PRICE GROUP**

 XR160 SEA-GREEN	 XR430 DARK TURQUOISE	 XR026 NAVY BLUE	 XR084 VIOLET	 XR009 BLACK		
 XR420 OLIVE	 XR081 DARK GREY	 XR094 GREY	 XR108 BEIGE	 XR079 RED		

## TECHNICAL SPECIFICATION

### MOBILE PEDESTAL WITHOUT HANDLES

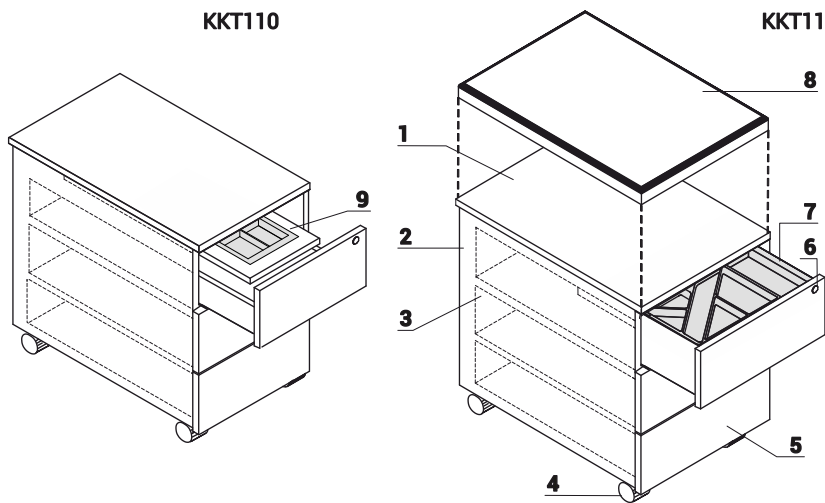

1. **Top** - MFC 6/8" | 18mm, PVC edge
2. **Body** - MFC 6/8" | 18mm, PVC edge
3. **Front** - MFC 6/8" | 18mm, PVC edge
4. **Castors** - O2" | O50mm, two with brakes
5. **Metal drawer** - roll runners, max load 25kg, 80% extraction; Anti - tilt mechanism
6. **Central lock** - foldable key
7. **Pencil tray** - black plastic
8. **Cushion SKP13** - for pedestal, order separately, max load 120kg
9. **Sliding pencil tray** - MFC 18mm | 6/8"

ATTENTION - no sitting on pedestal KKT11 without castors support; to be ordered with cushion SKP13

## PEDESTALS

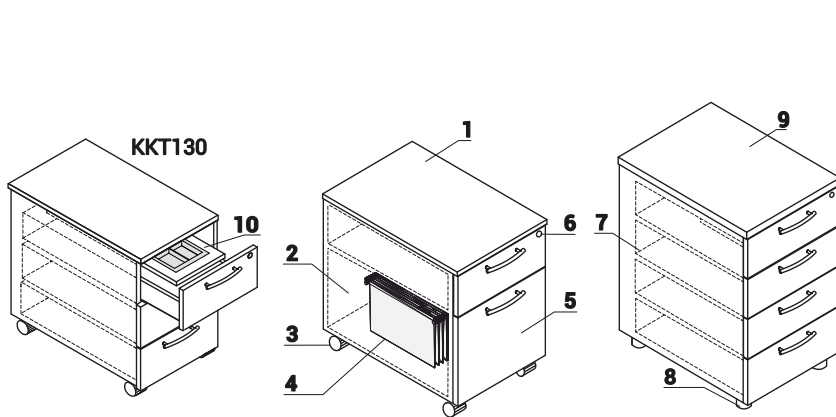

1. **Top** - MFC 6/8" | 18mm, PVC edge
2. **Body** - MFC 6/8" | 18mm, PVC edge
3. **Castors** - O2" | O50mm, two with brakes
4. **Suspension files drawer** - max load 30kg, 100% extraction
5. **Front** - MFC 6/8" | 18mm, PVC edge
6. **Central lock** - foldable key
7. **Metal drawer** - roll runners, max load 25kg, 80% extraction; Anti - tilt mechanism
8. **Leveling** - 2/8" | 5mm range
9. **Top** - MFC 1 1/8" | 25mm, PVC edge
10. **Sliding pencil tray** - MFC 18mm | 6/8"

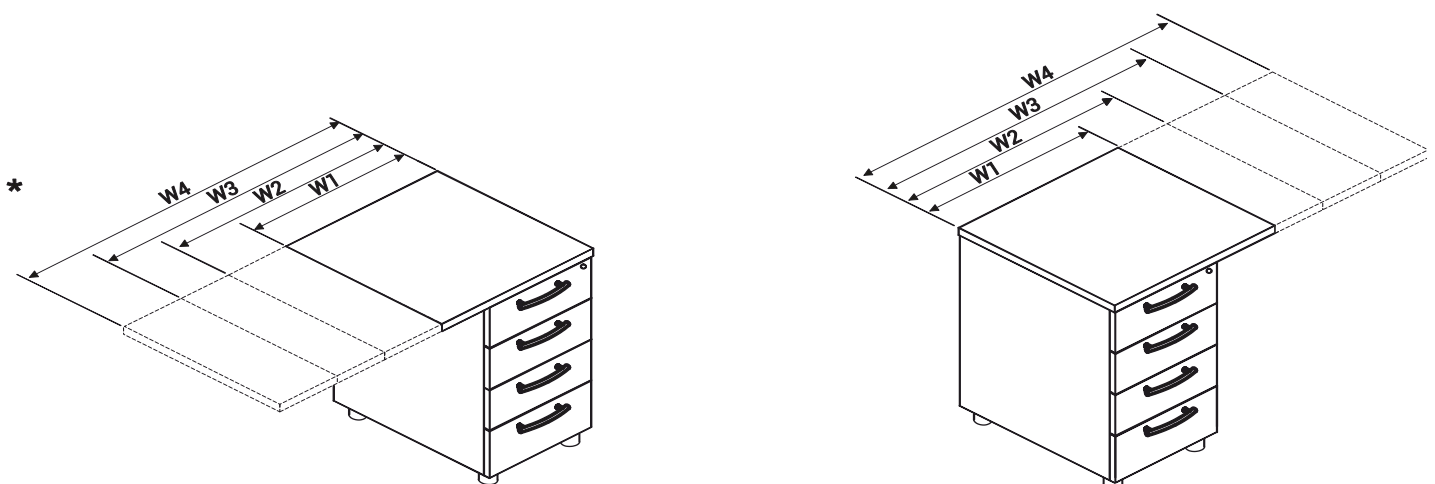

\* Pedestal with top overhang - W1 - 23 5/8" 600mm|W2 - 31 4/8" 800mm|W3 - 39 3/8" 1000mm|W4 - 47 2/8" 1200mm

PRODUCT ILLUSTRATION	DIMENSIONS [mm]/[inch]			INDEX SYMBOL						COMMENTS
	WIDTH	DEPTH	HEIGHT			kg	m3	pcs		

## MOBILE PEDESTAL WITHOUT HANDLES

	348 13 3/4"	600 23 5/8"	586 23 1/8"	<b>KKT110</b>		22.0	0.122	1		no handles, colours: white, aluminum, anthracite
	416 16 3/8"	600 23 5/8"	586 23 1/8"	<b>KKT11</b>		26.0	0.153	1		no handles, colours: white, aluminum, anthracite

## PEDESTAL CUSHION

	400 15 3/4"	600 23 5/8"	52 2"	<b>SKP13</b>		3.0	0.017	1		
--	----------------	----------------	----------	--------------	--	-----	-------	---	--	--

## PEDESTALS

	334 13 1/8"	600 23 5/8"	586 23 1/8"	<b>KKT130</b>		22.0	0.120	1		
	402 15 7/8"	600 23 5/8"	586 23 1/8"	<b>KKT13</b>		26.0	0.142	1		
	402 15 7/8"	600 23 5/8"	586 23 1/8"	<b>KKT12</b>		32.0	0.141	1		
	402 15 7/8"	600 23 5/8"	740 29 1/8"	<b>KKT64</b>		34.0	0.195	1		
	402 15 7/8"	800 31 1/2"	740 29 1/8"	<b>KKT74</b>		37.0	0.258	1		

DESCRIPTION

- NET WEIGHT

VOLUME

NUMBER OF PACKAGES

PRODUCT ILLUSTRATION	DIMENSIONS [mm]/[inch]			INDEX SYMBOL						COMMENTS
	WIDTH	DEPTH	HEIGHT			kg	m3	pcs		
<b>PEDESTLS WITH TOP OVERHANG 600 mm WIDE</b>										
	600 23 5/8"	600 23 5/8"	740 29 1/8"	<b>KT664</b>		35.0	0.209	4		Flat bar for fixing to the top included
	600 23 5/8"	800 31 1/2"	740 29 1/8"	<b>KT674</b>		39.0	0.275	4		Flat bar for fixing to the top included
<b>PEDESTLS WITH TOP OVERHANG 800 mm WIDE</b>										
	800 31 1/2"	600 23 5/8"	740 29 1/8"	<b>KT864</b>		37.0	0.213	4		Flat bar for fixing to the top included
	800 31 1/2"	800 31 1/2"	740 29 1/8"	<b>KT874</b>		41.9	0.281	4		Flat bar for fixing to the top included
<b>PEDESTLS WITH TOP OVERHANG 1000 mm WIDE</b>										
	1000 39 3/8"	600 23 5/8"	740 29 1/8"	<b>KT1064</b>		38.9	0.218	4		Flat bar for fixing to the top included
	1000 39 3/8"	800 31 1/2"	740 29 1/8"	<b>KT1074</b>		44.9	0.287	4		Flat bar for fixing to the top included
<b>PEDESTLS WITH TOP OVERHANG 1200 mm WIDE</b>										
	1200 47 1/4"	600 23 5/8"	740 29 1/8"	<b>KT1264</b>		41.4	0.222	4		Flat bar for fixing to the top included
	1200 47 1/4"	800 31 1/2"	740 29 1/8"	<b>KT1274</b>		47.9	0.293	4		Flat bar for fixing to the top included

DESCRIPTION

- NET WEIGHT

VOLUME

NUMBER OF PACKAGES

## TECHNICAL SPECIFICATION

### COLOURS

#### TOP, BOTTOM



14 BEECH



26 ALUMINUM  
SATINATO



31 CANADIAN OAK



34 CHESTNUT



39 POLAR BIRCH



64 COCOA

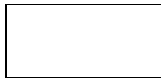

67 WHITE PASTEL



106 LOWLAND NUT



154 ANTHRACITE

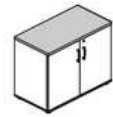

#### BODY



26 ALUMINUM  
SATINATO



67 WHITE PASTEL



154 ANTHRACITE



#### FRONT



14 BEECH



26 ALUMINUM  
SATINATO



31 CANADIAN OAK



34 CHESTNUT



39 POLAR BIRCH



64 COCOA

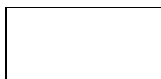

67 WHITE PASTEL

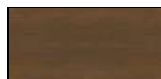

106 LOWLAND NUT



154 ANTHRACITE

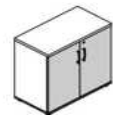

#### TOP, BOTTOM, BODY



154 ANTHRACITE



26 ALUMINUM  
SATINATO

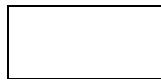

67 WHITE PASTEL



#### FRONT - TAMBOUR



08 BLACK



09 ALUMINUM

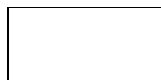

30 WHITE



## TECHNICAL SPECIFICATION

### STORAGES

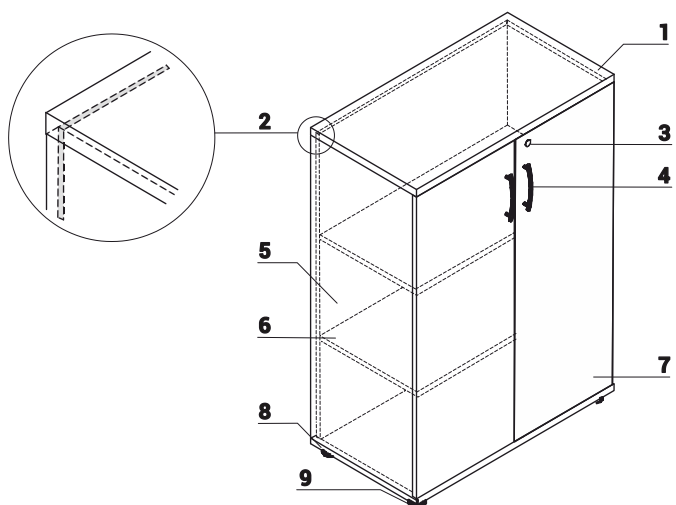

1. **Top** - MFC 1 1/8" | 25mm, PVC edge
2. **HDF back** - 1/8" | 3mm
3. Patent lock
4. Aluminium handle
5. **Side panels** - MFC 6/8" | 18mm, PVC edge
6. **Shelf** - MFC 6/8" | 18mm, PVC edge
7. **Front** - MFC 18mm | 6/8", PVC edge, plain hinge 110°
8. **Base** - MFC 6/8" | 18mm, PVC edge
9. **Leveling feet** 1 1/8" | 27mm - range 4/8" | 12mm

ATTENTION - Raw 3mm | 1/8" HDF is visible on the back

### ADDITIONAL ELEMENTS FOR STORAGE

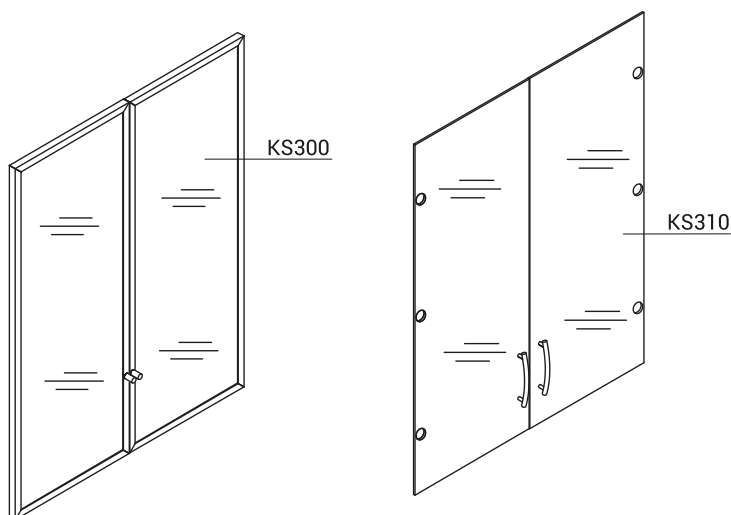

KS300  
glass door 30H  
**Frosted tempered glass 1/8" | 4mm-** with aluminum frame

KS310  
glass door 30H  
Transparent tempered glass 1/8" | 4mm



PRODUCT ILLUSTRATION	DIMENSIONS [mm]/[inch]			INDEX SYMBOL						COMMENTS
	WIDTH	DEPTH	HEIGHT			kg	m3	pcs		

## 50H STORAGES

	801 31 1/2"	385 15 1/8"	1833 72 1/8"	<b>K5504</b>		40.0	0.100	2		visible back panel, raw HDF 3mm
	801 31 1/2"	385 15 1/8"	1833 72 1/8"	<b>K5404</b>		47.0	0.120	3		visible back panel, raw HDF 3mm
	801 31 1/2"	385 15 1/8"	1833 72 1/8"	<b>K5304</b>		51.3	0.126	3		visible back panel, raw HDF 3mm
	801 31 1/2"	385 15 1/8"	1833 72 1/8"	<b>K5104</b>		58.7	0.142	3		visible back panel, raw HDF 3mm
	801 31 1/2"	385 15 1/8"	1833 72 1/8"	<b>K5204</b>		50.0	0.116	3		wardrobe with slide out hanger, raw 3mm HDF is visible on the back, no zip
	801 31 1/2"	385 15 1/8"	1833 72 1/8"	<b>K52P4</b>		56.6	0.139	3		wardrobe/storage cabinet with slide-out hanger

## 30H STORAGES

	801 31 1/2"	385 15 1/8"	1129 44 1/2"	<b>K3504</b>		25.0	0.059	2		visible back panel, raw HDF 3mm
	801 31 1/2"	385 15 1/8"	1129 44 1/2"	<b>K3404</b>		32.0	0.078	3		visible back panel, raw HDF 3mm
	801 31 1/2"	385 15 1/8"	1129 44 1/2"	<b>K3104</b>		36.3	0.085	3		visible back panel, raw HDF 3mm

DESCRIPTION

- NET WEIGHT

VOLUME

NUMBER OF PACKAGES

PRODUCT ILLUSTRATION	DIMENSIONS [mm]/[inch]			INDEX SYMBOL						COMMENTS
	WIDTH	DEPTH	HEIGHT			kg	m3	pcs		
<b>2OH STORAGEES</b>										
	801 31 1/2"	385 15 1/8"	777 30 5/8"	<b>K2504</b>		19.0	0.049	2		visible back panel, raw HDF 3mm
	801 31 1/2"	385 15 1/8"	777 30 5/8"	<b>K2104</b>		26.0	0.069	3		visible back panel, raw HDF 3mm
	801 31 1/2"	385 15 1/8"	740 29 1/8"	<b>K25B4</b>		18.5	0.048	2		
	801 31 1/2"	385 15 1/8"	740 29 1/8"	<b>K21B4</b>		25.0	0.067	3		
<b>2 OH STACK-ON STORAGEES</b>										
	801 31 1/2"	385 15 1/8"	750 29 1/2"	<b>K1504</b>		19.0	0.049	2		back - HDF 3mm
	801 31 1/2"	385 15 1/8"	750 29 1/2"	<b>K1104</b>		26.0	0.069	3		back - HDF 3mm
<b>TAMBOUR STORAGE</b>										
	1200 47 1/4"	385 15 1/8"	1129 44 1/2"	<b>K3Z06</b>		64.0	0.600	1		Top and body available in colors: 26 – aluminum satinato; 67 – white pastel, 154 – anthracite Tambour front available in colors: 09 – aluminum; 08 – black or 30 - white
<b>PRINTER STORAGE</b>										
	710 28"	600 23 5/8"	600 23 5/8"	<b>S85</b>		32.0	0.066	1		under printer storage, all in 26-aluminum satinato or 67-white pastel or 154-anthracite

DESCRIPTION

- NET WEIGHT

VOLUME

NUMBER OF PACKAGES

PRODUCT ILLUSTRATION	DIMENSIONS [mm]/[inch]			INDEX SYMBOL						COMMENTS
	WIDTH	DEPTH	HEIGHT			kg	m3	pcs		

## ADDITIONAL ELEMENTS FOR STORAGE

	800 31 1/2"	5 1/4"	1050 41 3/8"	<b>KS310</b>		12.0	0.034	1		glass doors (2pcs) 3OH, transparent tempered glass
	800 31 1/2"	20 3/4"	1050 41 3/8"	<b>KS300</b>		10.3	0.037	1		glass doors (2pcs) 3OH with aluminum frame, frosted tempered glass

DESCRIPTION

- NET WEIGHT

VOLUME

NUMBER OF PACKAGES